

TONO Elements: Brassware

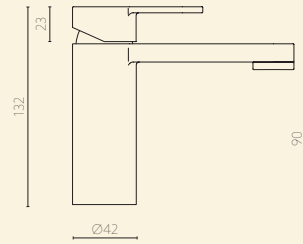
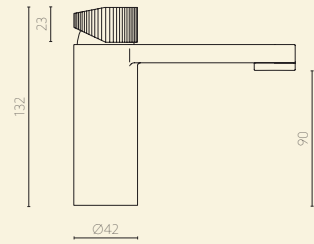
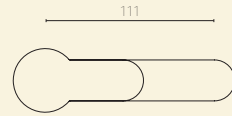
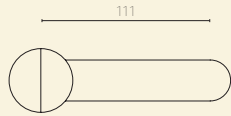
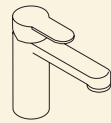
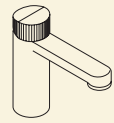

Basin Mixer

Features:
 Ø25 mm Ceramic cartridge
 Flow rate: 5.7 l/min at 3 bar
 Cartridge reliability meeting:
 European standard EN 817 and
 American standard ASME A112.18.1M
 Adjustable aerator
 Aerator for different building ratings available
 Ni-Cr coating tested to EN 248
 Flexi hose 3/8" connection, length 450mm
 Optional Ø48mm washer included

Basin Mixer with Lever

Features:
 Ø25 mm Ceramic cartridge
 Flow rate: 5.7 l/min at 3 bar
 Cartridge reliability meeting:
 European standard EN 817 and
 American standard ASME A112.18.1M
 Adjustable aerator
 Aerator for different building ratings available
 Ni-Cr coating tested to EN 248
 Flexi hose 3/8" connection, length 450mm
 Optional Ø48mm washer included

Finishes:

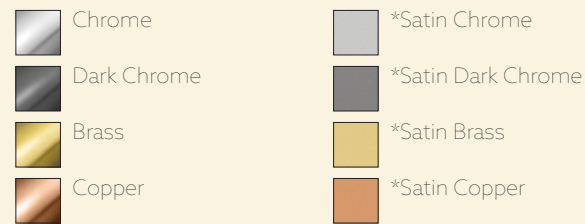

*Minimum order 50 pieces

Finishes:

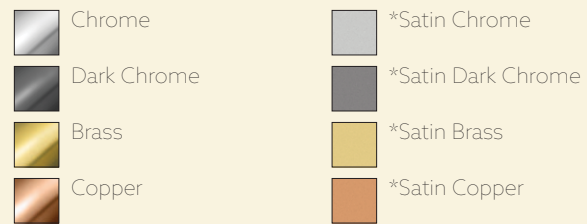

*Minimum order 50 pieces

TONO Elements: Brassware

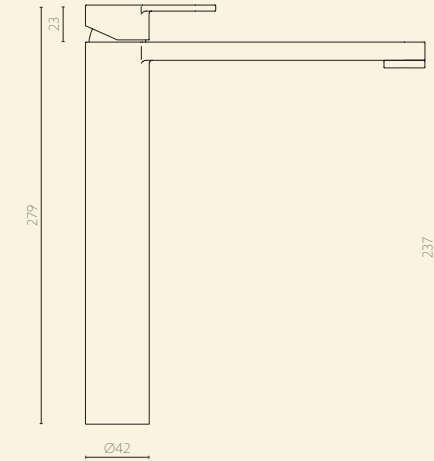
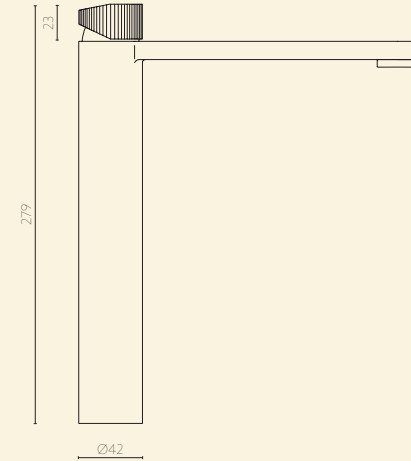
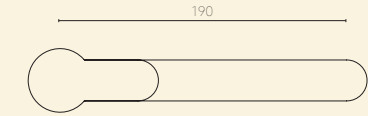
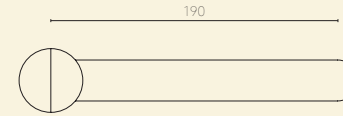
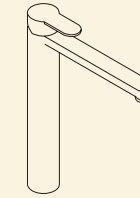
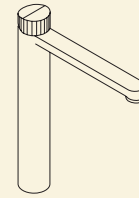

High Basin Mixer

Features:
 Ø25 mm Ceramic cartridge
 Flow rate: 5.7 l/min at 3 bar
 Cartridge reliability meeting:
 European standard EN 817 and
 American standard ASME A112.18.1M
 Adjustable aerator
 Aerator for different building ratings available
 Ni-Cr coating tested to EN 248
 Flexi hose 3/8" connection, length 450mm
 Optional Ø48mm washer included

High Basin Mixer with Lever

Features:
 Ø25 mm Ceramic cartridge
 Flow rate: 5.7 l/min at 3 bar
 Cartridge reliability meeting:
 European standard EN 817 and
 American standard ASME A112.18.1M
 Adjustable aerator
 Aerator for different building ratings available
 Ni-Cr coating tested to EN 248
 Flexi hose 3/8" connection, length 450mm
 Optional Ø48mm washer included

Finishes:

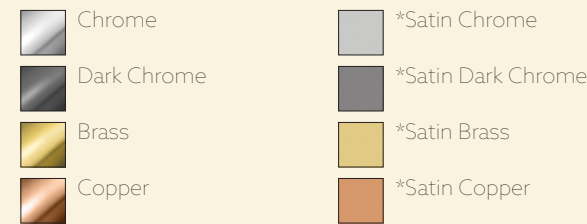

*Minimum order 50 pieces

Finishes:

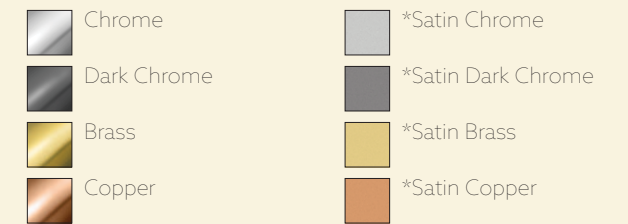

*Minimum order 50 pieces